

Practical Manual
on
Information & Communication Technology
2(1+1) Credit Hrs.
For B.Sc. (Hons.) Horticulture & Forestry course

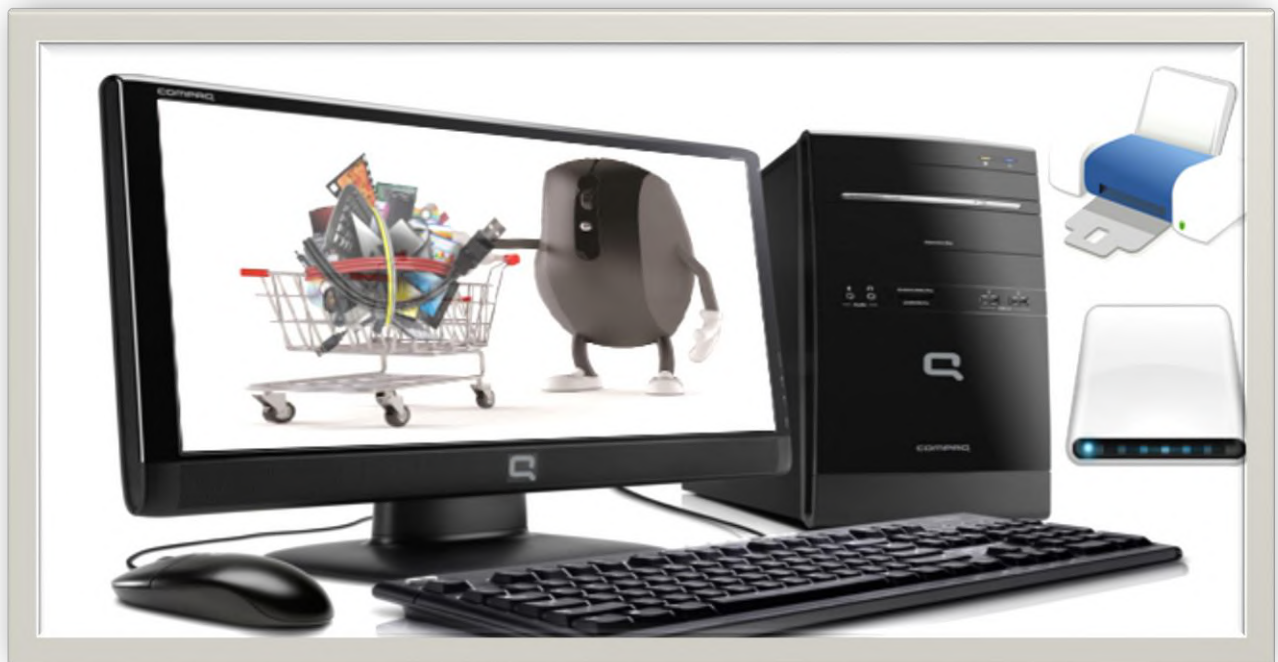

Amit Kumar Jain

Rani Lakshmi Bai Central Agricultural
University, Jhansi

Syllabus:

Practical: Exercises on binary number system, algorithm and flow chart; MS Word; MS Excel; MS Power Point; Internet applications: Web Browsing, Creation and operation of Email account; Analysis of fisheries data using MS Excel. Handling of audio-visual equipment's. Planning, preparation, presentation of posters, charts, overhead transparencies and slides. Organization of an audio-visual programme.

Name of Students

Roll No.

Batch

Session

Semester

Course Name :

Course No. :

Credit

Published: 2017

No. of copies:

Price: Rs.

CERTIFICATE

This is to certify that Shri./Km.ID No.....has completed the practical of course.....course No. as per the syllabus of B.Sc. (Hons.) Agriculture/ Horticulture/ Forestry semester in the year.....in the respective lab/field of College.

Date:

Course Teacher

CONTENTS

1	Computer Fundamentals- Input Devices	
2	Introduction to key Board	
3	Computer Fundamentals- Central Processing unit	
4	Computer Fundamentals- Central Processing unit Component	
5	Computer Fundamentals- Output Devices	
6	Computer Booting	
7	Introduction to binary number system (Decimal to binary)	
8	Introduction to binary number system (Binary to Decimal)	
9	Algorithm	
10	Flow Charts	
11	Microsoft Office Package (MS Word)	
12	MS Excel	
13	MS Excel Formula Bar	
14	MS Excel Statistical Analysis	
15	MS Power Point	
16	Web Browsing	
17	Creation of an Email Account	
18	Audio Visual Aids	

Practical 1: Computer Fundamentals - Input Devices

Objective: To study of basic Input Devices of Computer

Input Device- Input devices are used to enter data to the computer systems. Some most common input devices are Keyboard, Mouse, Scanner, trackball, Joystick, web camera etc.

Keyboard- Computer keyboard is most common and very important input device, which is used for input data into to computer. The keyboard is like of typewriter which consist of keys like numerical key alphabets and some functions keys. The standard US QWERTY keyboard has 101, 104 or 107 keys. Of those keys they can (by default) produce 96 unique characters.

Mouse – A Computer Mouse is also a most common input device it is also called a pointing device. That is most often used with a personal computer. Moving a mouse along a flat surface can move the on-screen cursor to different items on the screen. Items can be moved or selected by pressing the mouse buttons (called clicking).



Track Ball - These devices work like a standard mouse except the users rolls a ball inside a base rather than moving the device across the table top. Many users prefer a trackball to a mouse, because it involves less wrist movement, reducing repetitive-motion issues.



Touch Pad - This is a device typically found on laptop computers. It works like a mouse or trackball, except it's a flat panel you move your finger across. The motion of your finger registers as cursor movement on the screen. Many touchpads now enable gestures to scroll through documents or zoom in on a photo. Buttons are typically below the touchpad.



Joy Stick - These devices are primarily used for computer gaming. They consist of a stick on a base with various buttons that all have different functions. It operates similar to a yoke on an aircraft, making them suitable for flight simulators.



Scanner -These devices allow a user to input a photograph or document into the computer. By placing a piece of media in a scanner, you can create an image file that can be opened and manipulated on the computer.



Exercise:

1. Write the name of different input devices

.....
.....
.....
.....
.....
.....
.....
.....
.....
.....

2. Write the function of input devices.

.....
.....
.....
.....
.....
.....
.....
.....
.....
.....
.....
.....
.....
.....
.....
.....
.....
.....
.....
.....
.....
.....
.....

Practical 2: Introduction to Keyboard

Objective: To acquaint about introduction and functions of keyboard

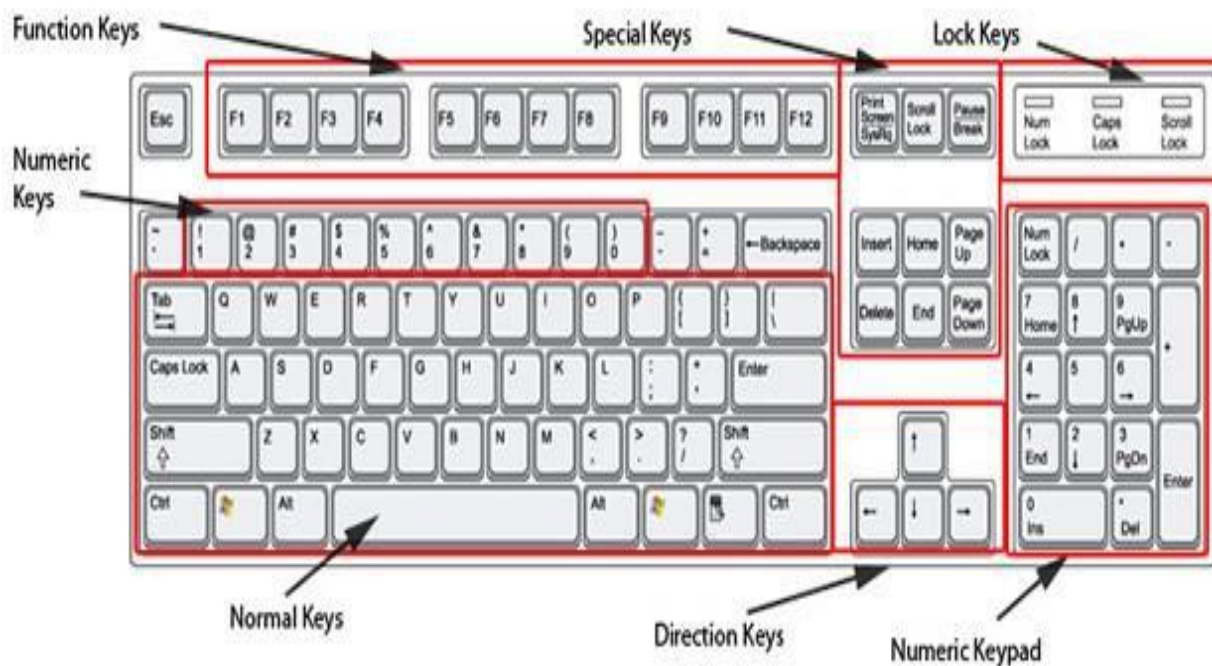

Keyboard has already been defined in previous practical.

Types of keys on a computer keyboard:

Alphanumeric keys – all of the letters and numbers on the keyboard. A-Z and 0-9.

Punctuation keys – All of the keys associated with punctuation such as the comma, period, semicolon, brackets, and parenthesis and so on. Also, all of the mathematical operators such as the plus sign, minus sign, and equal sign.

Special keys – All of the other keys on the computer keyboard such as the function keys, control keys, arrow keys, caps lock key, delete key, etc. Special keys on a PC Keyboard

Alt key – Short for Alternate, this key is like a second control key.

Arrow Keys – Most keyboards have four arrow keys that enable you to move the cursor (or insertion point) up, down, right, or left. Used in conjunction with the Shift or Alt keys, the arrow keys can move the cursor more than one position at a time, but this depends on which program is running.

Backspace key - Deletes the character just to the left of the cursor (or insertion point) and moves the cursor to that position.

Caps Lock Key – A toggle key that, when activated, causes all alphabetic characters to be uppercase.

Ctrl key – Short for Control, this key is used in conjunction with other keys to produce control characters. The meaning of each control character depends on which program is running.

Delete Key – Sometimes labeled Del, deletes the character at the current cursor position, or the selected object, but does not move the cursor. For graphics-based applications, the Delete key deleted the character to the right of the insertion point.

Enter Key – Used to enter commands or to move the cursor to the beginning of the next line. Sometimes labeled Return instead of Enter.

Esc Key – Short for Escape, this key is used to send special codes to devices and to exit (or escape) from programs and tasks.

Function Keys – Special keys labeled F1 to F12. These keys have different meaning depending on which program is running.

Key/Symbol	Explanation
Windows	PC keyboards have a Windows key that looks like a four-pane window
Command	Apple Mac computers have a command key.
Menu	PC keyboards also have a Menu key that looks like an cursor pointing to a menu.
Esc	Esc (Escape) key
F1 - F12	Information about the F1 through F12 keyboard keys.
F13 - F24	Information about the F13 through F24 keyboard keys.
Tab	Tab key
Caps lock	Caps lock key
Shift	Shift key
Ctrl	Ctrl (Control) key
Fn	Fn (Function) key
Alt	Alt (Alternate) key (PC Only; Mac users have Option key)
Spacebar	Spacebar key
Arrows	Up, Down, Left, Right Arrow keys
Back Space	Back space (or Backspace) key
Delete	Delete or Del key
Enter	Enter key
Prt Scrn	Print screen key
Scroll lock	Scroll lock key
Pause	Pause key
Break	Break key
Insert	Insert key
Home	Home key
Page up	Page up or pg up key
Page down	Page down or pg dn key
End	End key
Num Lock	Num Lock key
~	Tilde
`	Acute, Back quote, grave, grave accent, left quote, open quote, or a push
!	Exclamation mark, Exclamation point, or Bang
@	Ampersat, Arobase, Asperand, At, or At symbol
#	Octothorpe, Number, Pound, sharp, or Hash
£	Pounds Sterling or Pound symbol
€	Euro
\$	Dollar sign or generic currency
¢	Cent sign
¥	Chinese/Japenese Yuan
§	Micro or Section
%	Percent
°	Degree

^	Caret or Circumflex
&	Ampersand, Epershand, or And
*	Asterisk and sometimes referred to as star.
(Open parenthesis
)	Close parenthesis
-	Hyphen, Minus or Dash
_	Underscore
+	Plus
=	Equal
{	Open Brace, squiggly brackets, or curly bracket
}	Close Brace, squiggly brackets, or curly bracket
[Open bracket
]	Closed bracket
	Pipe, Or, or Vertical bar
\	Backslash or Reverse Solidus
/	Forward slash, Solidus, Virgule, or Whack
:	Colon
;	Semicolon
"	Quote, Quotation mark, or Inverted commas
'	Apostrophe or Single Quote
<	Less Than or Angle brackets
>	Greater Than or Angle brackets
,	Comma
.	Period, dot or Full Stop
?	Question Mark

Exercise:

Q. Write the functions of function keys of keyboard

.....

.....

.....

.....

.....

.....

.....

.....

.....

.....

.....

.....

.....

.....

.....

.....

.....

.....

.....

.....

.....

.....

.....

Practical 3: Computer Fundamentals: Central Processing Unit

Objective: To know about Central Processing Unit

Central Processing Unit: Central processing unit also called CPU is the most important part of computer. It's called brain of computer. Its reads and execute the program instruction. CPU consist Arithmetic and logical unit (ALU), memory unit and control unit.

Central processing unit consist of three parts namely Arithmetic logical unit, control unit and memory management.

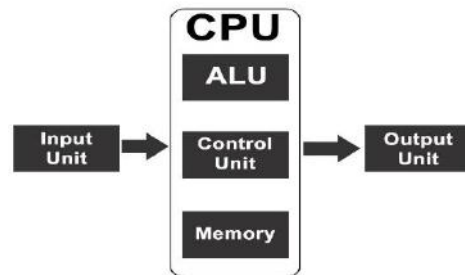

Block diagram of computer

ALU- Arithmetic and logical unit perform logical and mathematical function.

Control Unit- control the input and output devices.

Memory Unit- Store Program and data.

Output Unit- decode information and present it to the user.

Exercise:

Q. Write the different component of CPU.

.....

.....

.....

.....

.....

.....

.....

.....

.....

.....

.....

.....

.....

.....

.....

.....

.....

.....

.....

.....

.....

.....

Practical 4: Computer Fundamentals: Central Processing Unit components

Objective: To learn about Central Processing Unit and its Functioning

CPU have different units and includes processors. All the unit of CPU given below-

Process is a program to execute, which requires processor. Basically, there are two company based processors Intel and AMD. Out of these two a number of varieties are available in these processors, which are given below-

- I) Intel include Pentium pro, Celeron, Pentium IV, Dual Core, Core to Duo, I3, I5, I7 series processors with 32 and 64 bits.
- II) AMD include AMD Athlon ,AMD FX™ processors , AMD Athlon™ processors, AMD A-Series APUs AMD Athlon™ APUs AMD Sempron™ APUs.



Memory Unit: Memory unit is the most important part of CPU. It also called the main memory of computer system. It stores data, program instruction, internal result and final output temporary before it is sent to an appropriate output device. Memory unit consists of thousands memory location and data are store in it in the form of 0 and 1.

A computer memory is two type:

- 1) Primary Memory
- 2) Secondary memory

Primary Memory: This is the most important part of the computer. Primary memory also called internal memory in which all the computer task and data and instructions are stored.

Primary memory is of two type: (A) Random Access Memory (RAM); (B) Read Only memory (ROM)

RAM: Random Access memory or RAM is the primary memory or main memory of the computer system. It is also called read write memory as the information can be read and write on to it. CPU can direct access the data from the RAM. RAM is a volatile memory, everything written on the RAM is lost when power supply is off or system is shutdown.

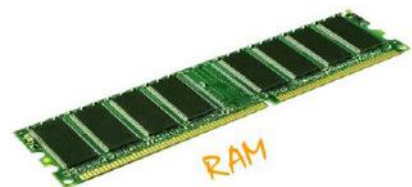

ROM: ROM stands for Read Only Memory as the information can read only not written anything on it. It is a non-volatile memory. There is no effect of power on the ROM. Its stores some basic input output instruction put by the company to operate the computer.



Secondary Memory: Primary memory is not sufficient for storage large number of data and instructions. Thus, extra memory is needed, which is called secondary storage memory. The data may be stored in permanent manner. User can work on system and saved it on the secondary memory for future use. Computer hard disk is the best example of secondary storage device. Optical disk, Magnetic Type, Floppy disk, CD, DVD etc. are the example of secondary storage devices.



Arithmetic Logic Unit: An arithmetic logic unit (ALU) is a digital circuit used to perform arithmetic and logic operations. It represents the fundamental building block of the central processing unit (CPU) of a computer. Modern CPUs contain very powerful and complex ALUs. In addition to ALUs, modern CPUs contain a control unit (CU).

Most of the operations of a CPU are performed by one or more ALUs, which load data from input registers. A register is a small amount of storage available as part of a CPU. The control unit tells the ALU what operations are to be performed on that data and the ALU stores the result in an output register. The control unit moves the data between these registers, the ALU, and memory.

Control unit: A control unit or CU is circuitry that directs operations within a computer's processor. It lets the computer's logic unit, memory, as well as both input and output devices know how to respond to instructions received from a program. Examples of devices that utilize control units include CPUs and GPUs.

A control unit works by receiving input information that it converts into control signals, which are then sent to the central processor. The computer's processor then tells the attached hardware what operations to carry out. The functions that a control unit performs are dependent on the type of CPU, due to the variance of architecture between different manufacturers. The following diagram illustrates how instructions from a program are processed.

Exercise:

Q.1 What is CPU? Write the different parts of CPU.

.....
.....
.....
.....
.....
.....
.....
.....
.....
.....
.....

Q.2 Write the main work of ALU?

.....
.....
.....
.....
.....
.....
.....
.....
.....

Q.3 Write down primary work of RAM & ROM.?

.....
.....
.....
.....
.....
.....

Practical 5: Computer Fundamentals: Output Devices

Objective: To know about Computer Output Devices

An output device is any peripheral that receives data from a computer, usually for display, projection, or physical reproduction. Most commonly output devices are Monitor, Printer, and Speaker etc.

Monitor: Monitor is the most common output device in the computer. The monitor is the piece of computer hardware that displays the video and graphics information generated by the computer through the video card. Monitors are very similar to televisions but usually display information at a much higher resolution. Also, unlike televisions, monitors are not usually mounted on a wall but instead sit atop a desk. A monitor is sometimes referred to as a screen, display, video display, video display terminal, video display unit, or video screen.



A monitor, no matter the type, usually connects to either an HDMI, DVI, or VGA port. Other connectors include USB, Display Port, and Thunderbolt. Before investing in a new monitor, make sure that both devices support the same type of connection.

Printer: Printer is also a most common output device. It transfers data from a system onto paper. There are many different types of printers. In terms of the technology utilized, printers fall into the following categories:



- **Daisy-wheel:** Similar to a ball-head typewriter, this type of printer has a plastic or metal wheel on which the shape of each character stands out in relief. A hammer presses the wheel against a ribbon, which in turn makes an ink stain in the shape of the character on the paper. Daisy-wheel printers produce letter-quality print but cannot print graphics.
- **Dot-matrix:** Creates characters by striking pins against an ink ribbon. Each pin makes a dot, and combinations of dots form characters and illustrations.
- **Ink-jet:** Sprays ink at a sheet of paper. Ink-jet printers produce high-quality text and graphics.
- **Laser:** Uses the same technology as copy machines. Laser printers produce very high-quality text and graphics.
- **LCD & LED:** Similar to a laser printer, but uses liquid crystals or light-emitting diodes rather than a laser to produce an image on the drum.
- **Line printer:** Contains a chain of characters or pins that print an entire line at one time. Line printers are very fast, but produce low-quality print.
- **Thermal printer:** An inexpensive printer that works by pushing heated pins against heat-sensitive paper. Thermal printers are widely used in calculators and fax machines.

Speaker: speaker is another type of output device, which produce sound and gives sound as an output.



Exercise

Q.1 Explain the different kinds of printers.

.....
.....
.....
.....
.....
.....
.....
.....
.....
.....
.....

Q.2 Write and explain the different types of output devices.

.....
.....
.....
.....
.....
.....
.....
.....
.....
.....
.....

Q.3 Explain the different kind of monitors.

.....
.....
.....
.....
.....
.....
.....
.....
.....

Practical 6: Computer Booting

Objective: How to boot the computer.

Booting: When we start our computer then there is an operation, which is performed automatically by the computer. This is called as booting. In booting, system will check all the hardware's and software's those are installed or attached with the system and this will also load all the files, which are needed for running a system. In the booting process, the system will read all the information from the files those are stored into the ROM chip and the ROM chip will read all the instructions those are stored into these files.

Booting are two types-

- 1) **Warm Booting:** When the system starts from the beginning or from initial stage, means when we starts our system, this is called as warm booting.
- 2) **Cold Booting:** The cold booting is that in which system automatically starts when we run the system, e.g., due to light fluctuation, the system will automatically restarts. System damage chances becomes more in this booting. The system will not be started from its initial state. Some files will be damaged because they are not properly stored into the system.

Shut down computer properly: In order to turn off computer, use Start menu, click the Start button, and then, in the lower-right corner of the Start menu, click Shut down. When you click Shut down, your computer closes all open programs, along with Windows itself, and then completely turns off your computer and display. Shut down button may be different places in different operating systems.

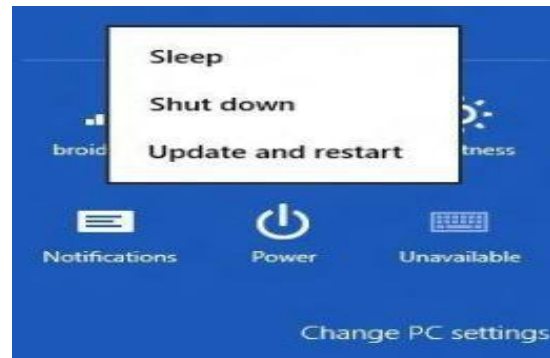

Exercise:

Q.1 What is booting?

.....
.....
.....
.....
.....

Q.2 How to shut down the computer?

.....
.....
.....
.....
.....

Q.3 What is the key combination of shutdown the computer?

.....
.....
.....
.....
.....

Practical No 7: Introduction to binary number systems

Objective: Convert binary to decimal and decimal to binary

As we know the computer understandable language is binary language. The 0s and 1s is the binary numbers or digital numbers. The single binary digit is called bit. For example, 110100 is the binary number consist of 6 bits. The table of binary numbers equivalent to decimal number given below

0	0000
1	0001
2	0010
3	0011
4	0100
5	0101
6	0110
7	0111
8	1000
9	1001
10	1010
11	1011
12	1100
13	1101
14	1110
15	1111

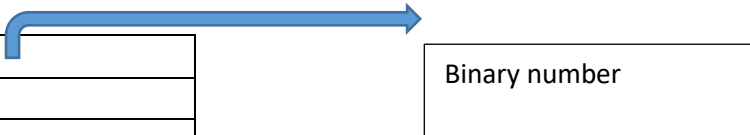

Binary number

Conversion binary to decimal

We can convert binary number in to decimal number.

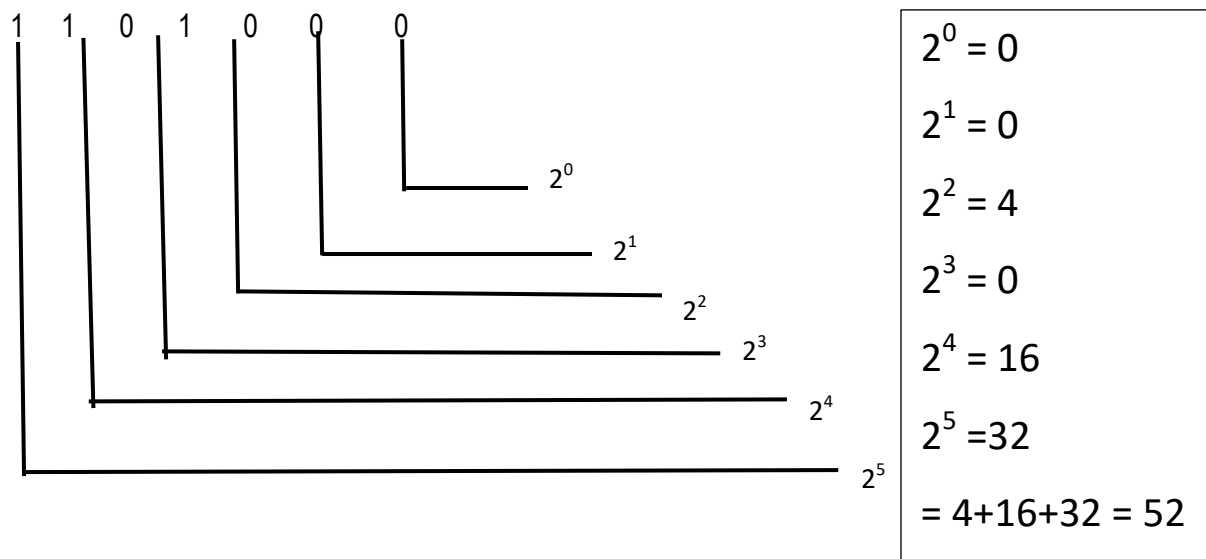

Practical No 8: Introduction to binary number systems

Objective: Conversion binary to Decimal

Convert 52 to binary

2	52		
2	26	0	
2	13	0	
2	6	1	
2	3	0	
	1	1	

→ 110100

Exercise

Q. 1 Convert the binary no to equivalent decimal numbers.

$(10011)_2$

$(110101)_2$

$(10001011)_2$

$(11111)_2$

$(111111)_2$

Q. 2 Convert Decimal to binary

$(56)_{10}$

$(65)_{10}$

$(58)_{10}$

$(101)_{10}$

Practical No 9: Algorithm

Objective: How to write an algorithm

Algorithm: An algorithm is a step by step process of any program or task. An algorithm is a procedure or formula for solving a problem. A computer program can be viewed as an algorithm. In mathematics and computer science, an algorithm usually means a small procedure that solves a problem. The word algorithm derives from the name of the mathematician, Mohammed ibn-Musa al-Khwarizmi, who was part of the royal court in Baghdad and who lived from about 780 to 850. Al-Khwarizmi's work is the likely source for the word algebra as well.

Example

Write an algorithm to find out number is odd or even?

Ans.

Step 1: start

Step 2: input number

Step 3: rem=number mod 2

Step 4: if rem=0 then

 Print "number even"

 Else

 Print "number odd"

 endif

Step 5: stop

An algorithm for calculating the perimeter and surface of square

1. start
2. Input A
3. PERIMETER = $4 \times A$
4. SURFACE = $A \times A$
5. Print PERIMETER, SURFACE
6. End/Stop

Exercise:

Q. Write an algorithm for addition of two numbers.

.....

.....

.....

.....

.....

.....

.....

.....

.....

.....

.....

.....

.....

.....

.....

.....

.....

.....

.....

.....

.....









.....

.....

Practical No: 10 Flow Charts

Objective: How to prepare flow charts.

Flow Charts: Flow charts is basically the pictorial representation of data flow. Data flow and data process can easily be understood by the flow charts. A flowchart contains different kind of symbols, which shows different meaning in data flow. Flowcharts use simple geometric symbols and arrows to define relationships. In programming, for instance, the beginning or end of a program is represented by an oval. A process is represented by a rectangle, a decision is represented by a diamond and an I/O process is represented by a parallelogram. The Internet is represented by a cloud.

Symbol	Purpose	Description
	Flow line	Used to indicate the flow of logic by connecting symbols.
	Terminal(Stop/Start)	Used to represent start and end of flowchart.
	Input/output	Used for input and output operation.
	Processing	Used for arithmetic operations and data-manipulations.
	Decision	Used to represent the operation in which there are two alternatives, true and false.
	On-page Connector	Used to join different flowline
	Off-page Connector	Used to connect flowchart portion on different page.
	Predefined Process/Function	Used to represent a group of statements performing one processing task.

Draw a flowchart to add two numbers.

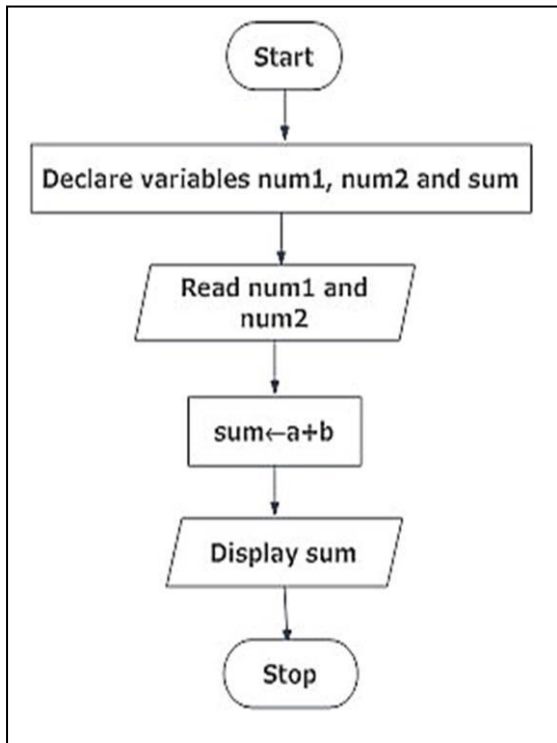

Draw flowchart to find the largest among three different numbers

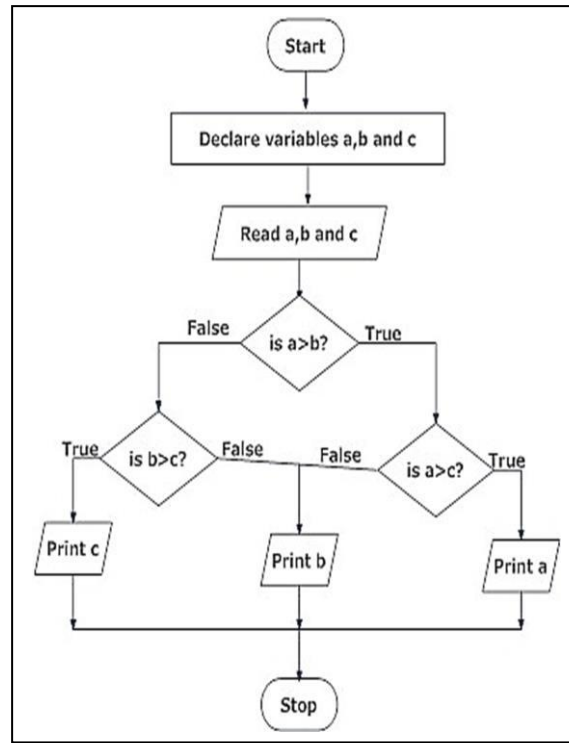

Exercise:

Q. Draw the flow charts of RLBCAU Academic Block.

Practical No 11: Microsoft Office Package (MS Word)

Objective: working with Microsoft office Word

Microsoft office package Suite of products developed by Microsoft Corporation that includes Microsoft Word, Excel, Access, Publisher, PowerPoint, and Outlook. Each program serves a different purpose and is compatible with other programs included in the package. The suite of programs is compatible with both the Windows and Macintosh operating system. Microsoft Office is the most common form of software used in the western world.

Word Processing is perhaps the most common and comparatively easier application to work on any computer. A word processor lets you to change words or phrases, to move whole sections of text from one place to another, store blocks of text, and align margins all in few seconds. Use of word processors has changed the look of official correspondence, reports, and proposals etc. to a great extent. MS Word is an advanced word processing product by Microsoft Company. The powerful features of Word will allow you to create even graphic based multicolumn publications such as Fliers, Newsletters and Internet web pages. This section provides an overview of MS - Word and deals with the following features:

- **Word-wrap:** automatic arrangement of text in lines of specified length without the necessity of touching the return key.
- **Discretionary Hyphenation:** option of inserting a hyphen to break a word that ends a line: the hyphen does not print if later editing moves the word to the middle of a line.
- **Justification:** automatic alignment of text to both the left and right margins.
- **Adjustment:** realignment of text to new margin and tab settings.
- **Alignment:** positioning text or numbers to specified margin and tab settings.
- **Decimal Alignment:** positioning columns of numbers with the decimal points vertically aligned.
- **Indents:** the setting of temporary margins within a document differing from the primary margins used.
- **Centering** text on a line.
- **Insertion:** the entry of new text within previously typed material without erasing the existing material.
- **Overstriking:** the substitution of new text for old by typing over the old text.
- **Deletion:** erasure of text from the screen, or of whole documents from the disk.
- **Search and Replace:** moving directly to specified words or parts of words within a document and replacing them with different words or word portions.
- **Copying or Cutting:** the duplication or moving of blocks of text within a document.
- **Boilerplate:** the separate storage and retrieval of blocks of text from which standard documents can be built.
- **Pagination:** automatic division of a document into pages of specified numbers of lines.
- **Page Numbering:** automatic sequential numbering of pages.
- **Headers and Footers:** option of creating standard blocks of text that will automatically appear at the top or bottom of each page in a document.
- **Footnoting:** automatic sequential numbering of footnotes and positioning of the footnotes at the bottom of their appropriate pages during pagination.
- **Table of Contents and Index Generators.** Programs that create these based on the text of a document.
- **Form Letter Merging:** automatic combining of a form letter with a mailing list to generate multiple copies of the letter with the different addresses and other variable information filled in.
- **Automatic Spelling Checker and Corrector.** Program that compares words in the text against an on-line dictionary, flagging items not found in the dictionary and offering alternative spellings and a means of correcting the errors.

How to open the MS word File

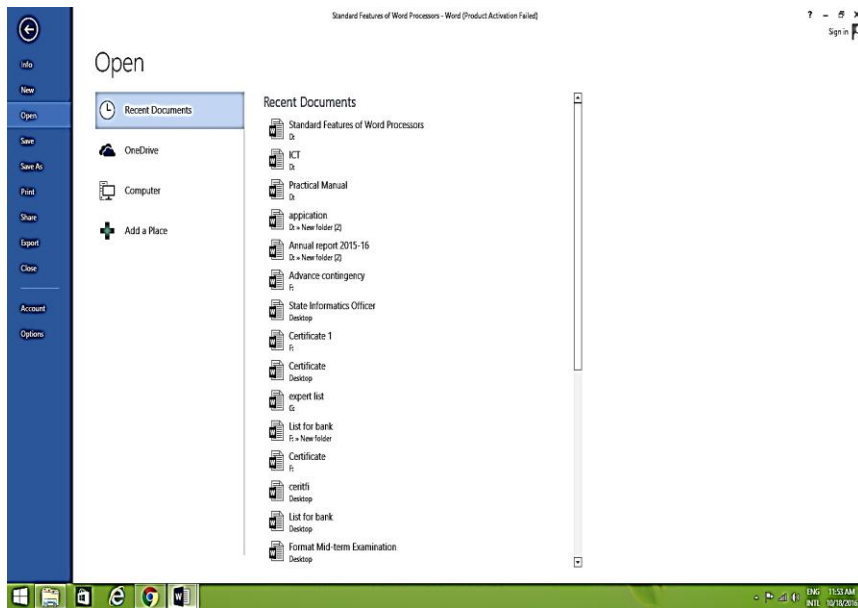

First view of MS word file

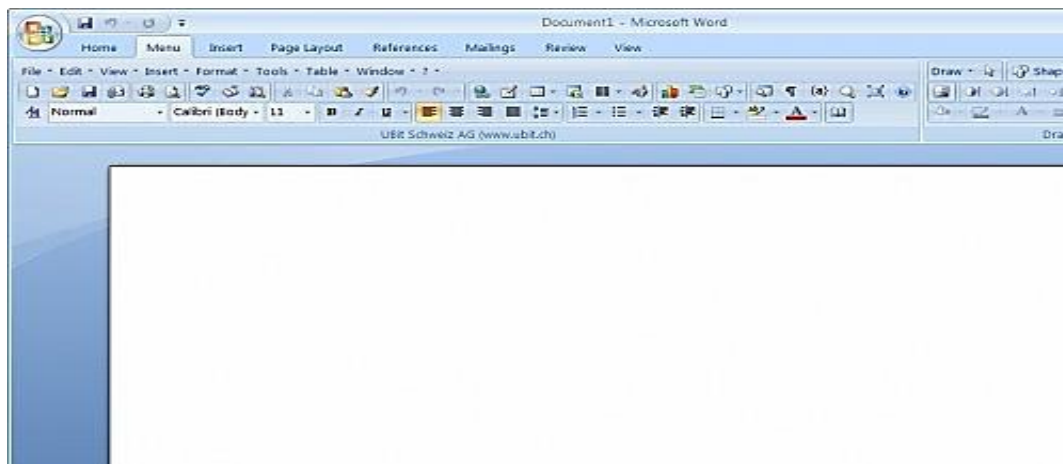

How to save the MS word File

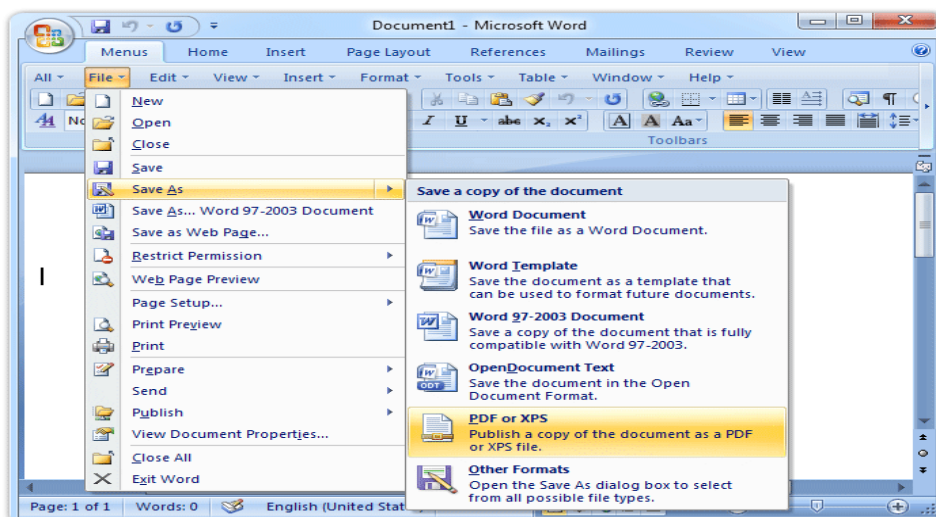

Standard Menu and Tools bar



How to change design and fonts size

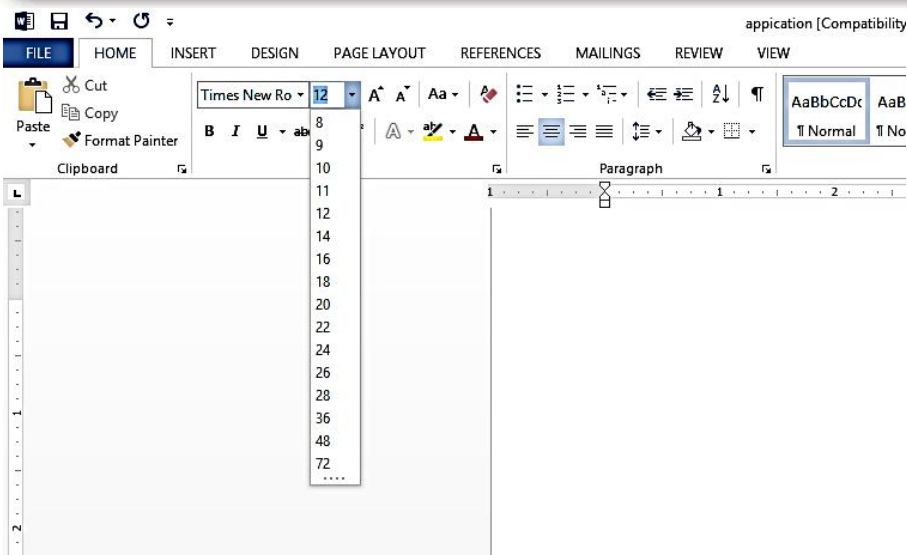
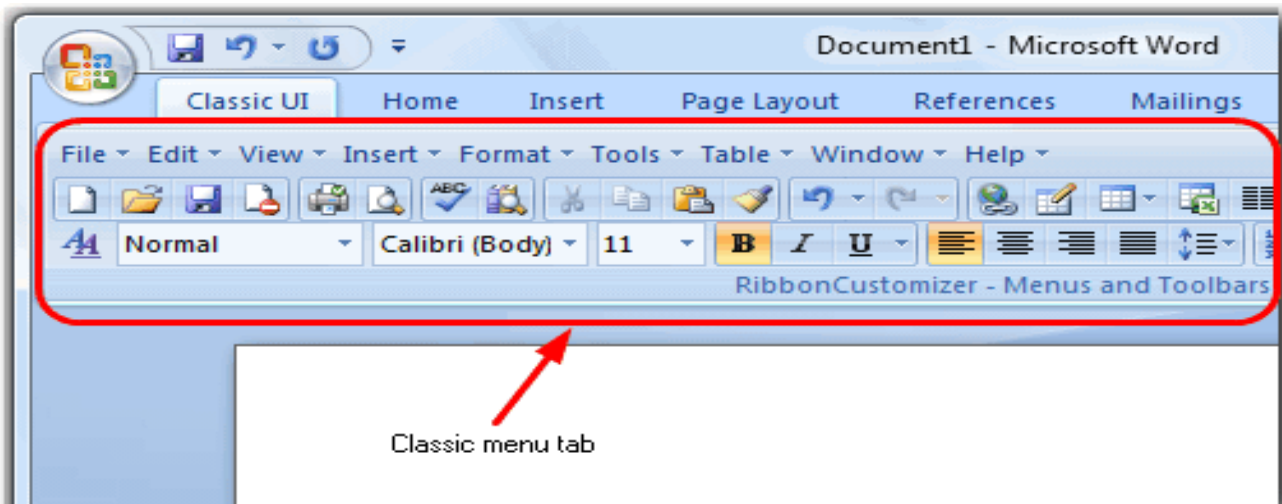

How to Secure Word Document

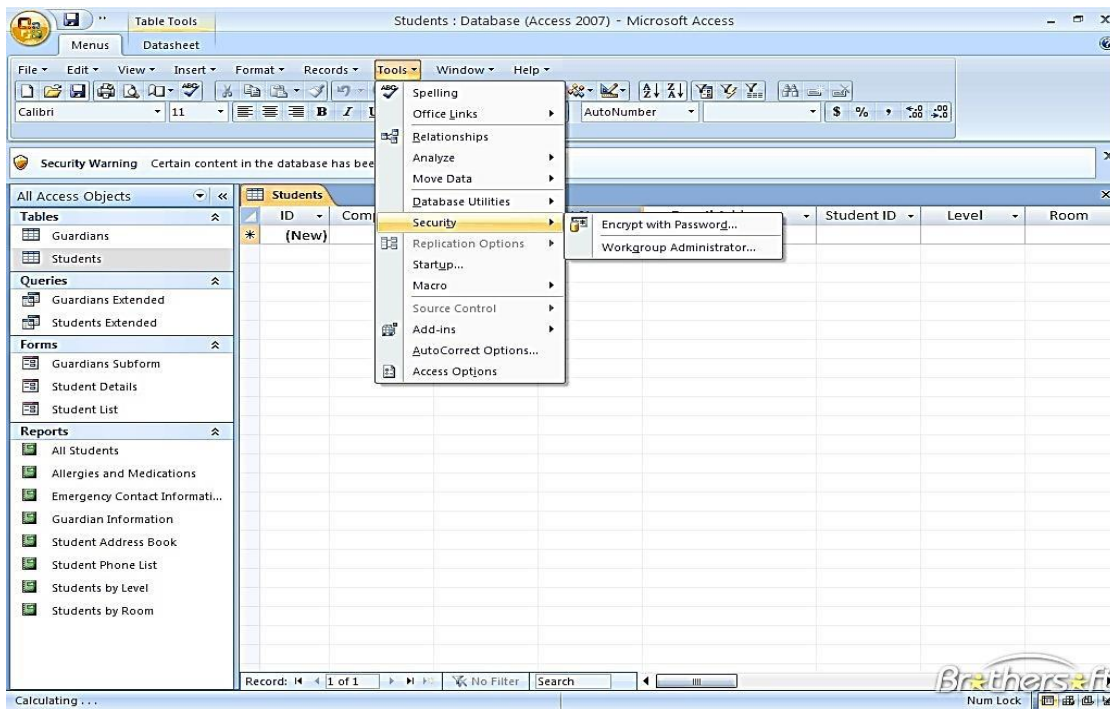

Exercise on Computer

Q.1 Create the Table in the word.

Q.2 How to insert the pics into word document

Q.3 How to change the font size and font style in the word document.

Practical No 12: MS excel

Objective: Working with MS excel

MS Excel: MS excel is another powerful tool of MS office package, it's also called spread sheet or electronic sheet. All the calculation, statistical analysis, all type of graphs easily made by the help of MS excel. Excel is, in its most basic form, a very fancy calculator. There are usually several different ways to perform the same function in Excel. Some features of excel are given below.

It is a spreadsheet application in which we can add sheets as per our requirements. In a single sheet, it consists of rows and columns and cells, where every cell has different address.

Sum, product, subtraction, division and many mathematical, logical functions are available within it.

Other features include tables, charts, clip art and more.

It is basically used for payroll, accounts, mathematical, and for other business purposes. See below for details.

Features:

Hyperlink. We can link one file to another file or page.

Clip art. We can add images and also audio and video clips.

Charts. With charts, we can clearly show a product(s) evaluation to a client. For example, you can display a chart showing which product is selling more or less by month, week, and so forth.

Tables. Tables are created with different fields (e.g. name, age, address, roll number, and so forth). You can add a table to fill these values.

Functions. There are both mathematical functions (add, subtract, divide, multiply), and logical ones (average, sum, mod, product).

Images and backgrounds. You can incorporate images and backgrounds into each sheet.

Macros. Macros are used for recording events for future use.

Database: With the data feature, you can add any database from other sources to it.

Sorting and filtering. We can sort and/or filter our data so that anything redundant or repetitive can be removed more easily.

Data validations. This tool can help you consolidate your data.

Grouping. The grouping feature helps you both to group your data and ungroup it so that you have subtotals and so forth.

Page layout. Themes, colors, sheets, margins, size, backgrounds, breaks, print, titles, sheets height, width, scaling, grids, headings, views, bring to front of font or back alignment, and many more are available for you to lay out your page.

Example of MS excel sheet

Starting look of MS Excel sheet

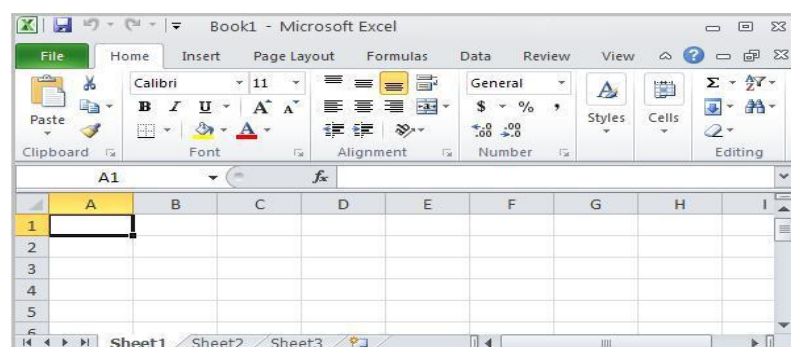

Menu and tools bar of MS Excel

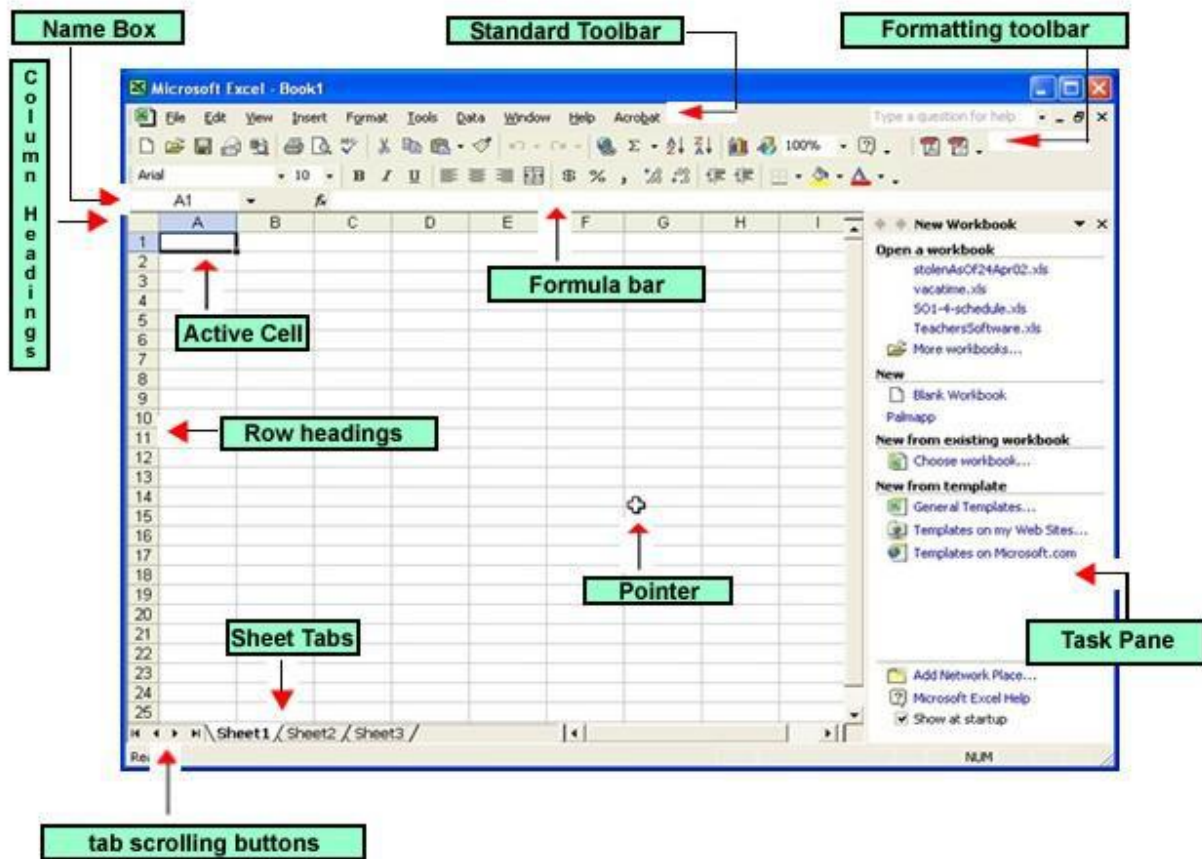

How to insert image, in excel sheet

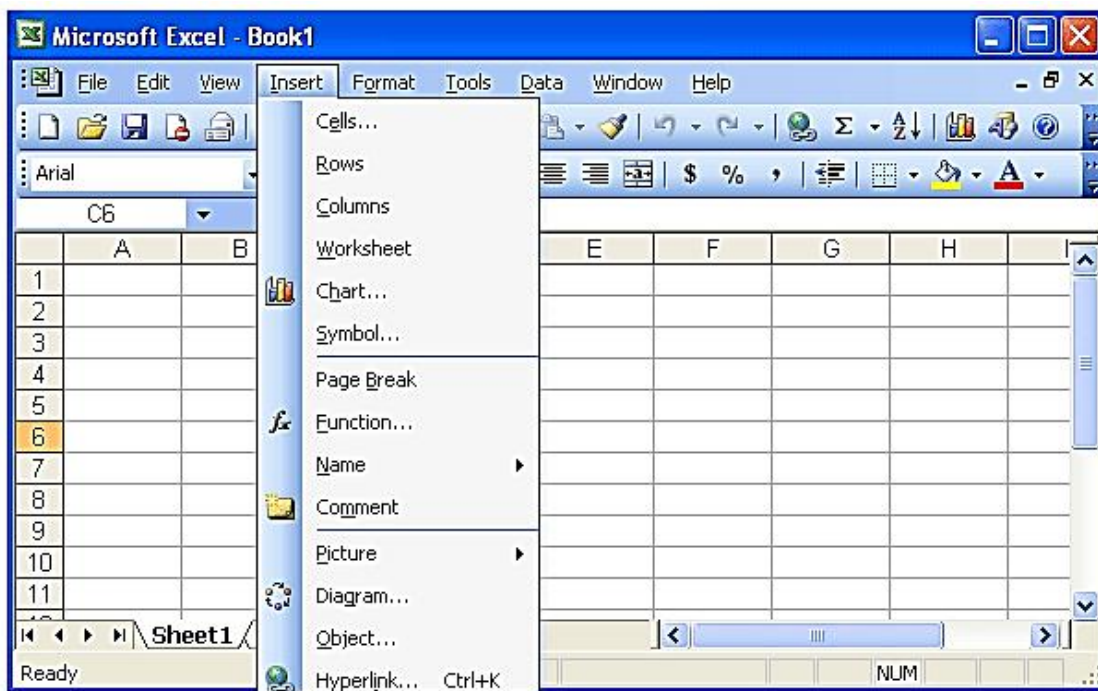

How to make a graph using Excel

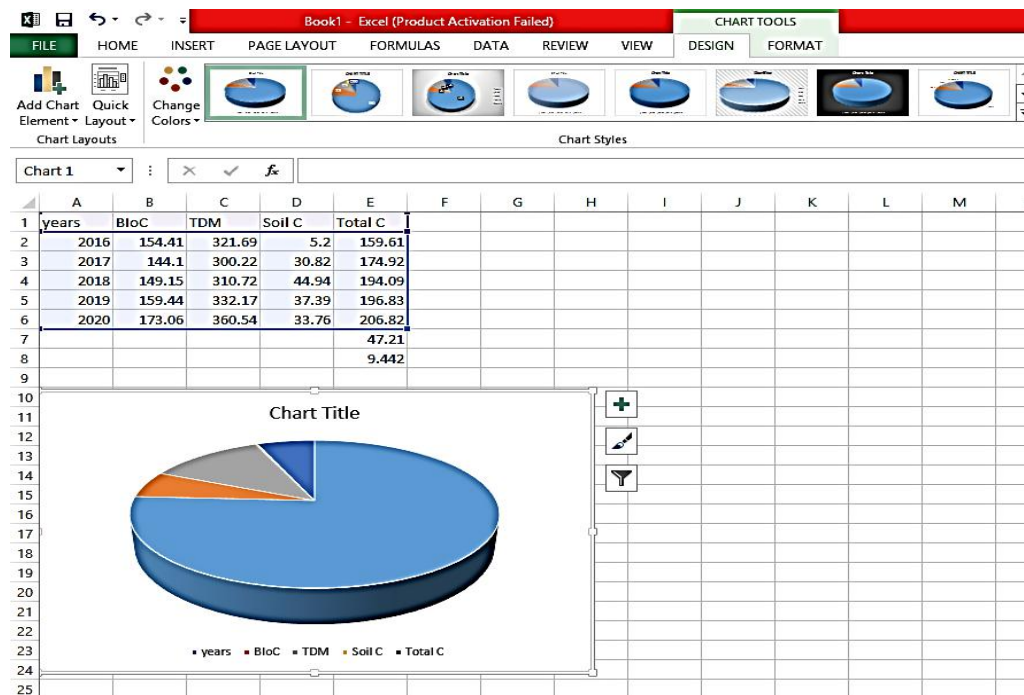
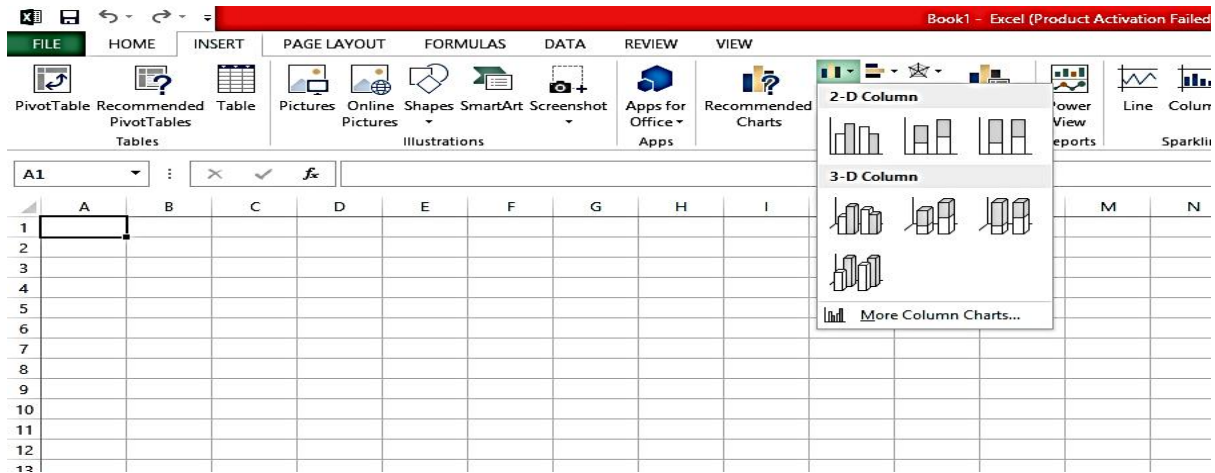

Exercise on
Computer

Q.1 How to
create the
charts in the
excel sheet.

Practical No 13: MS Excel Formula Bar

Objective: working with MS Excel and formula bar

MS excel is most powerful tools for calculation and feeding equation. Using excel we can make a small software for office automation, result preparation, salary sheet and many more. Here we learn about how to feed the equation in excel sheet.

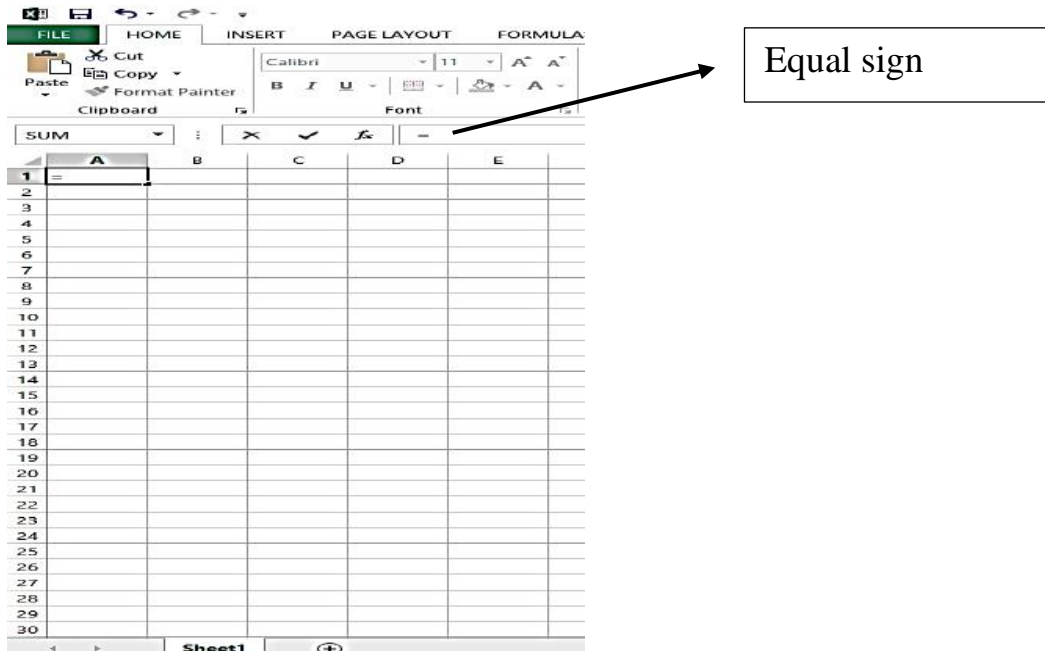

For insert the formula in the excel sheet first type the Equal sign using key board this shows that the user now enter the formula.

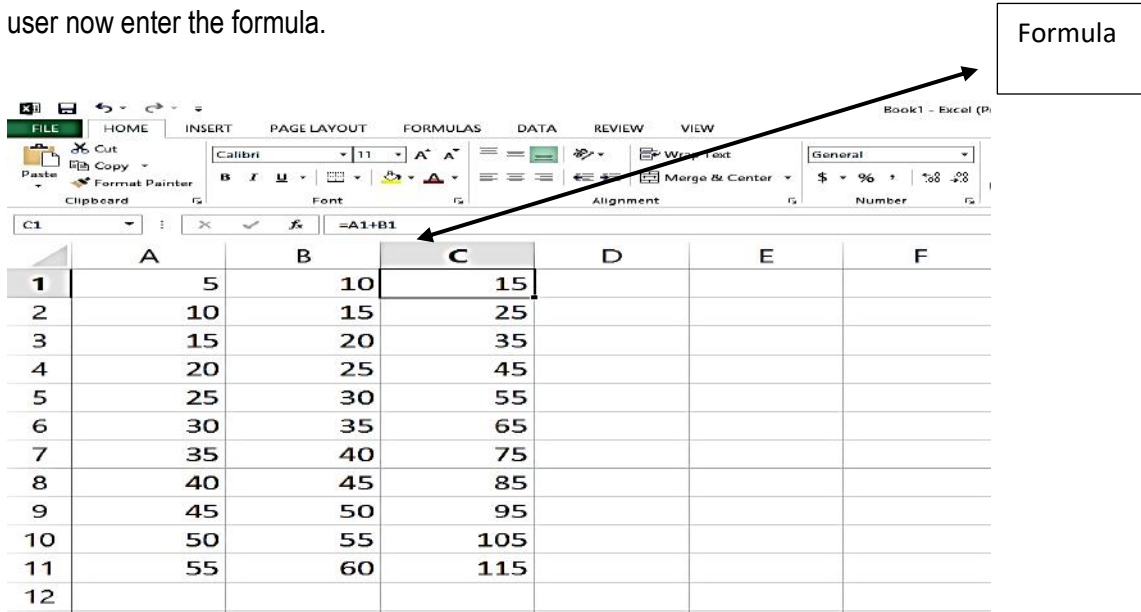

Exercise on Computer

1. Insert the formula in the excel sheet.

x	2	3	4	7	8
y	8	5	6	71	12

Find the value of z; $Z = (x+y)$, $Z = (x-y)$, $Z = (x*y)$

Practical No 14: MS Excel Statistical Analysis

Objective: Statistical Analysis done through MS-Excel

Statistical analysis is very important part of any project. Statistical analysis is very striking features of MS excel, here we learn how to analysis the data using excel.

First fill the data in data sheet and then select all the data and click on data on the menu Bar after that click on analysis tool. Here we find many statistical tools for analysis the data.

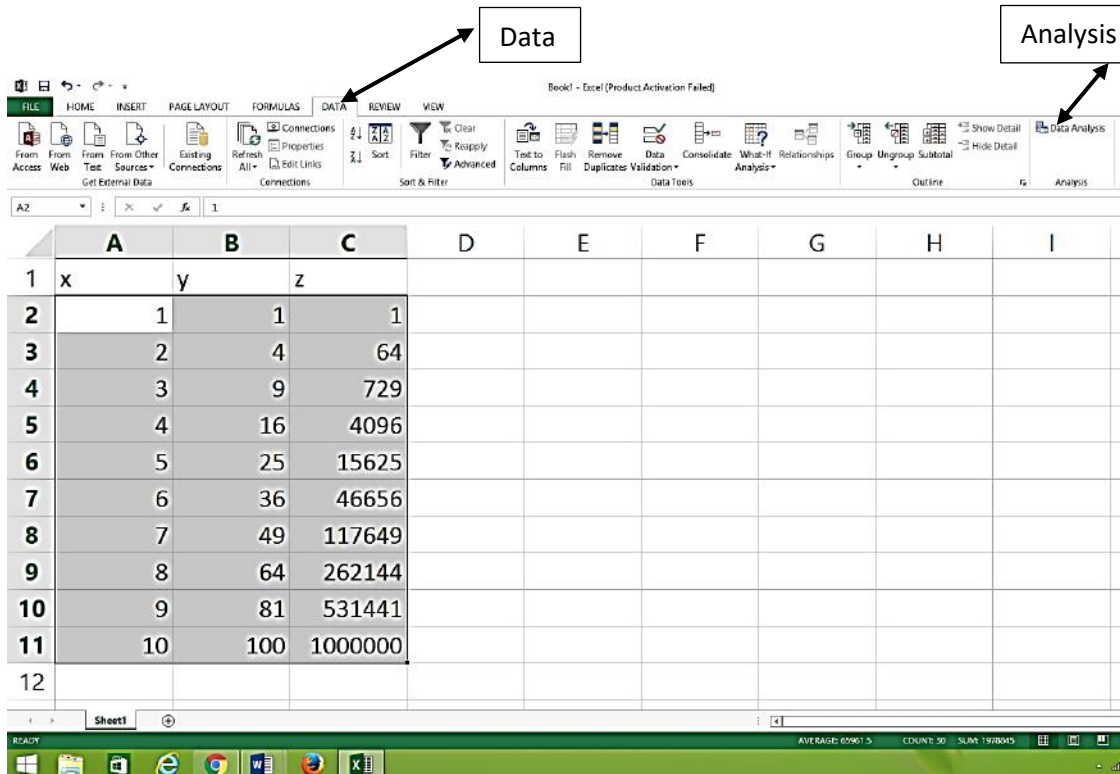

The screenshot displays the Microsoft Excel interface. The ribbon is set to the 'DATA' tab, with the 'Data Analysis' group expanded. A box labeled 'Data' points to the 'DATA' tab, and another box labeled 'Analysis' points to the 'Data Analysis' group. The spreadsheet contains the following data:

	A	B	C	D	E	F	G	H	I
1	x	y	z						
2	1	1	1						
3	2	4	64						
4	3	9	729						
5	4	16	4096						
6	5	25	15625						
7	6	36	46656						
8	7	49	117649						
9	8	64	262144						
10	9	81	531441						
11	10	100	1000000						
12									

The status bar at the bottom shows: AVERAGE: 65961.5 COUNT: 30 SUM: 1970045

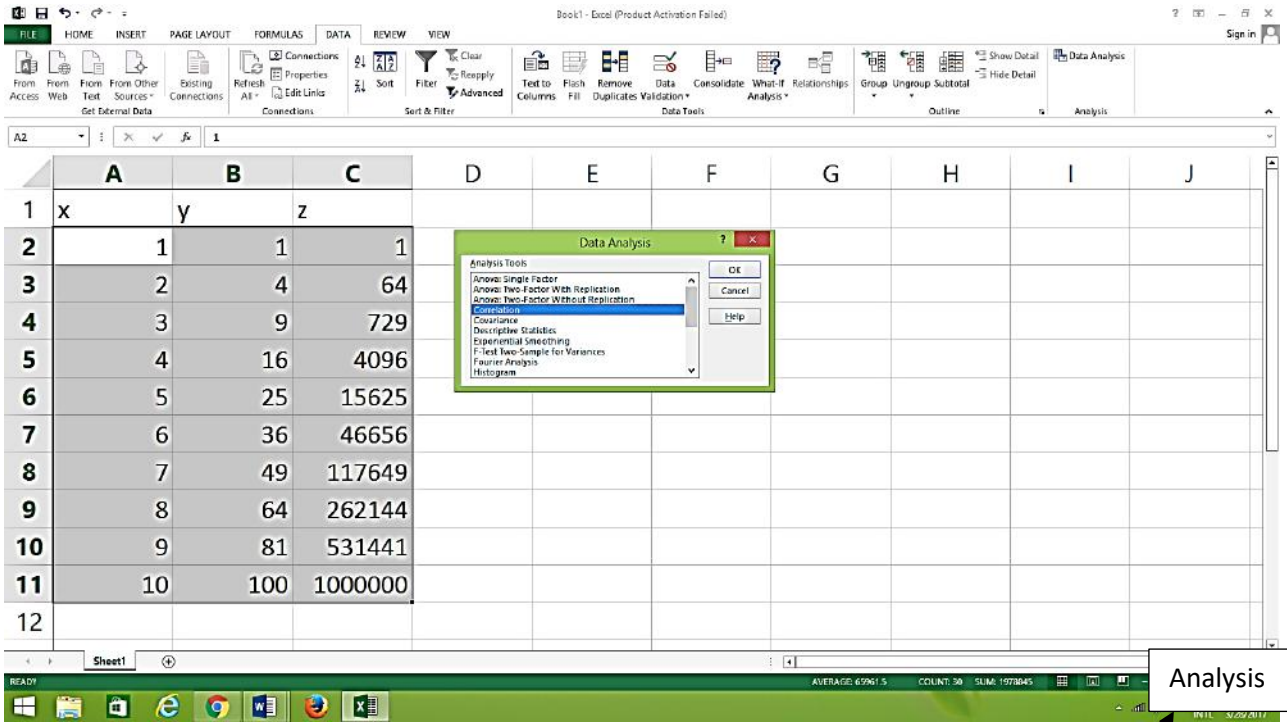

Exercise on Computer

Q. Find the correlation of given data

x	2	3	4	7	8
y	8	5	6	71	12

Practical No 15: MS Power Point

Objective: Working with MS PowerPoint

Microsoft power point presentation

Power point presentation is the most striking feature of MS office package. Using this tool it is easily to present the data, graph, images and many more.

Basic PowerPoint Features

Design

The design features of PowerPoint allow to customize the appearance and format of the slides. PowerPoint typically comes with a set of preloaded themes for you to choose from. These can range from simple color changes to complete format layouts with accompanying font text. Themes can be applied through the whole presentation or a single slide. Using the page setup allows you to optimize the presentation for the display size; for instance, you should use a larger screen ratio when displaying on a projector compared to a computer screen.

Animation

PowerPoint animation is divided between slide transitions and element animation. Using slide transition adds an effect when switching slides during a slide show. We can edit the transition effect and timing, as well as opt for an on-click or automatic transition between slides. Element animation adds movement and sounds to the objects within the slide. For example, if we are constructing a photo gallery as a slide show, we can choose which pictures enter the slide first, how they enter and add a sound as they enter.

Presentation

The presentation function of PowerPoint is largely designed to accommodate public speaking. PowerPoint comes with a built-in notes function; when printing out presentation slides, we can add presenter notes beside each slide as accompanying content.

Integration

PowerPoint is compatible with all other software in the Microsoft Office suite; we can export slides into Word documents or use Excel charts within presentation. In addition to image and audio support.

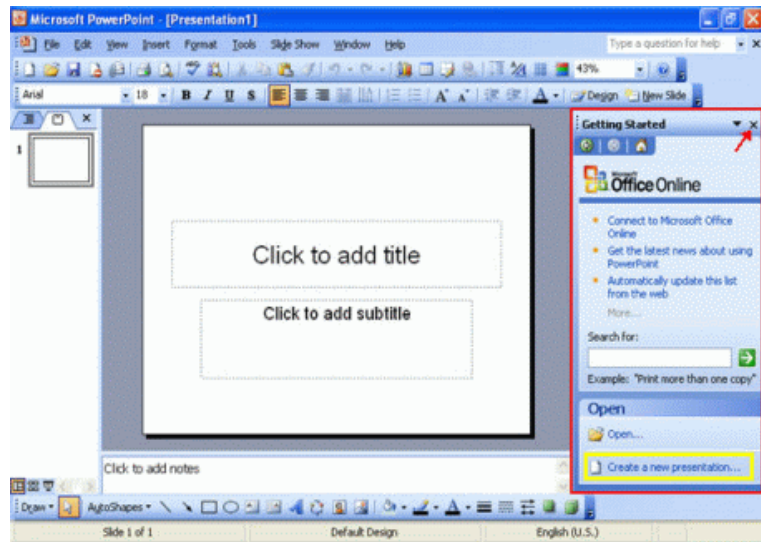

Start the Power Point presentation

Menu and tools bar

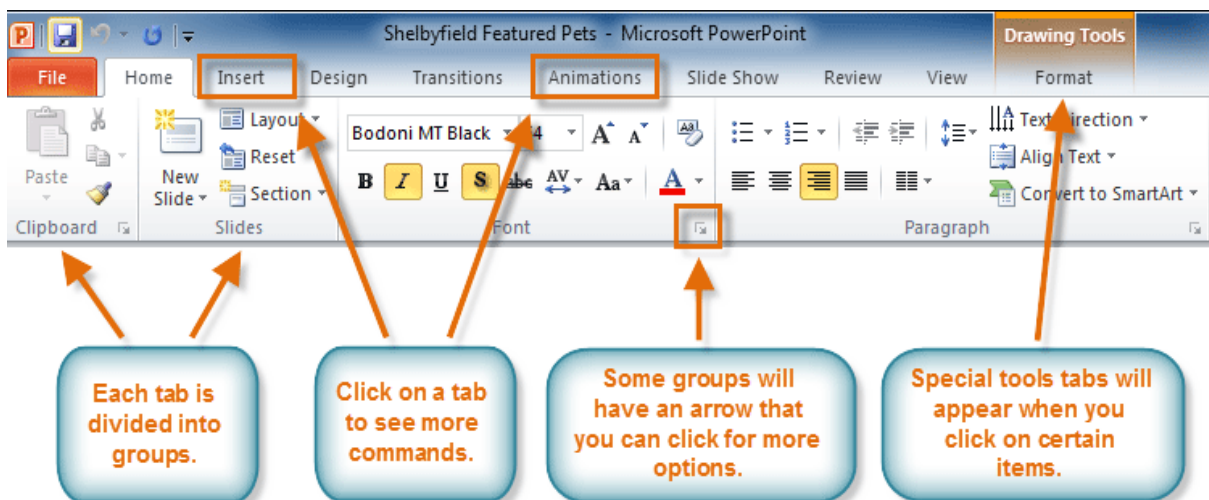
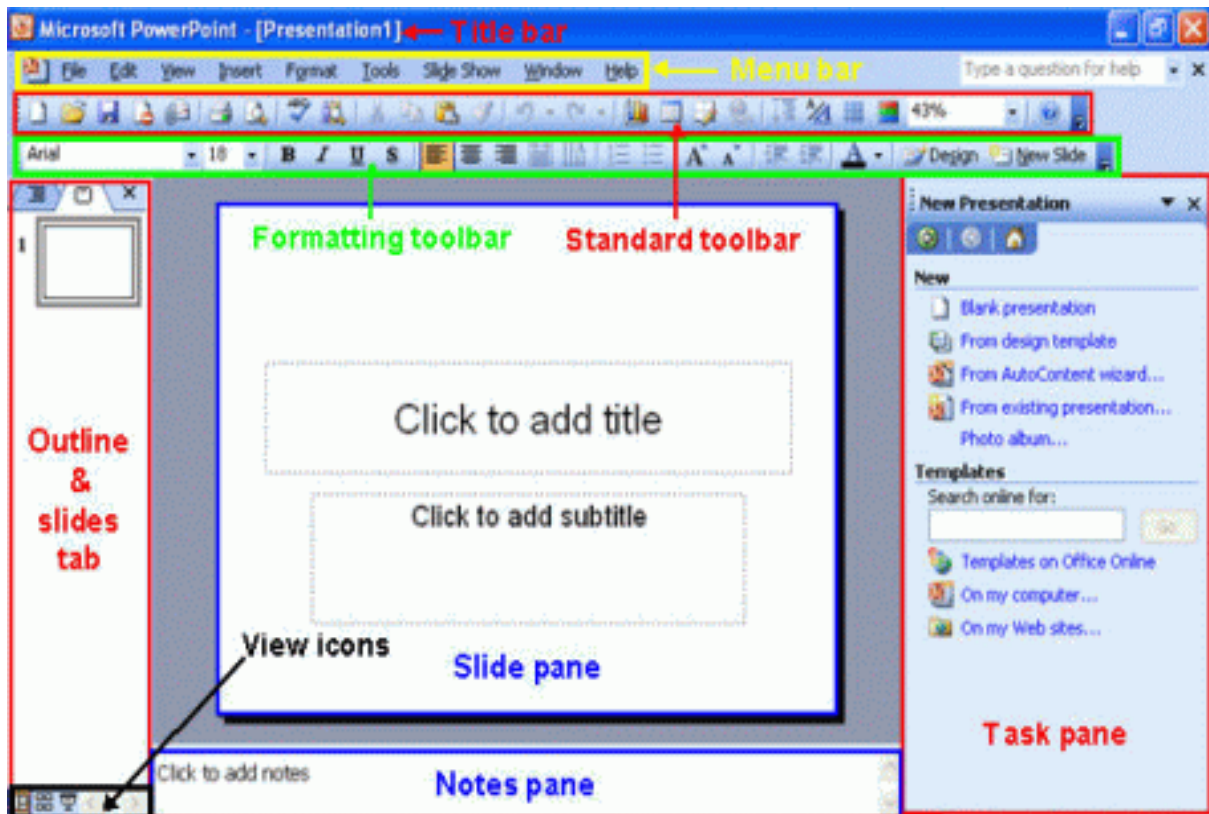

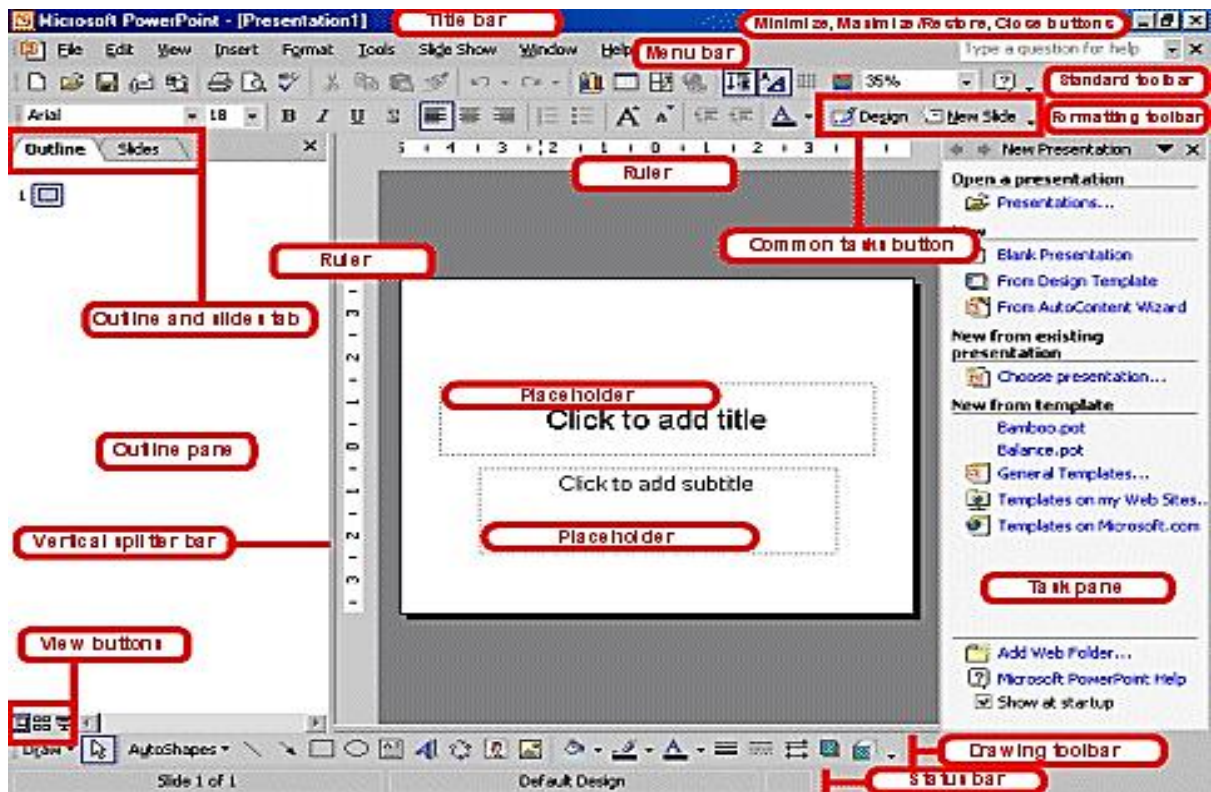

First Slide create using MS Power point

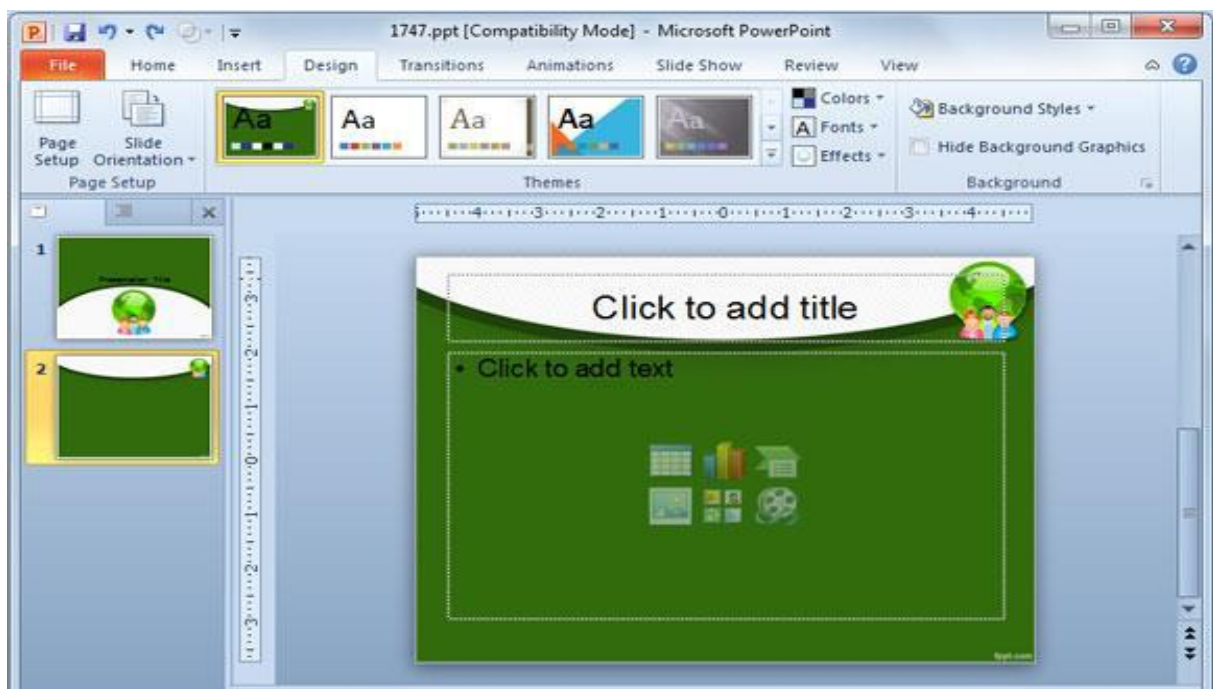

How to insert animation on slide

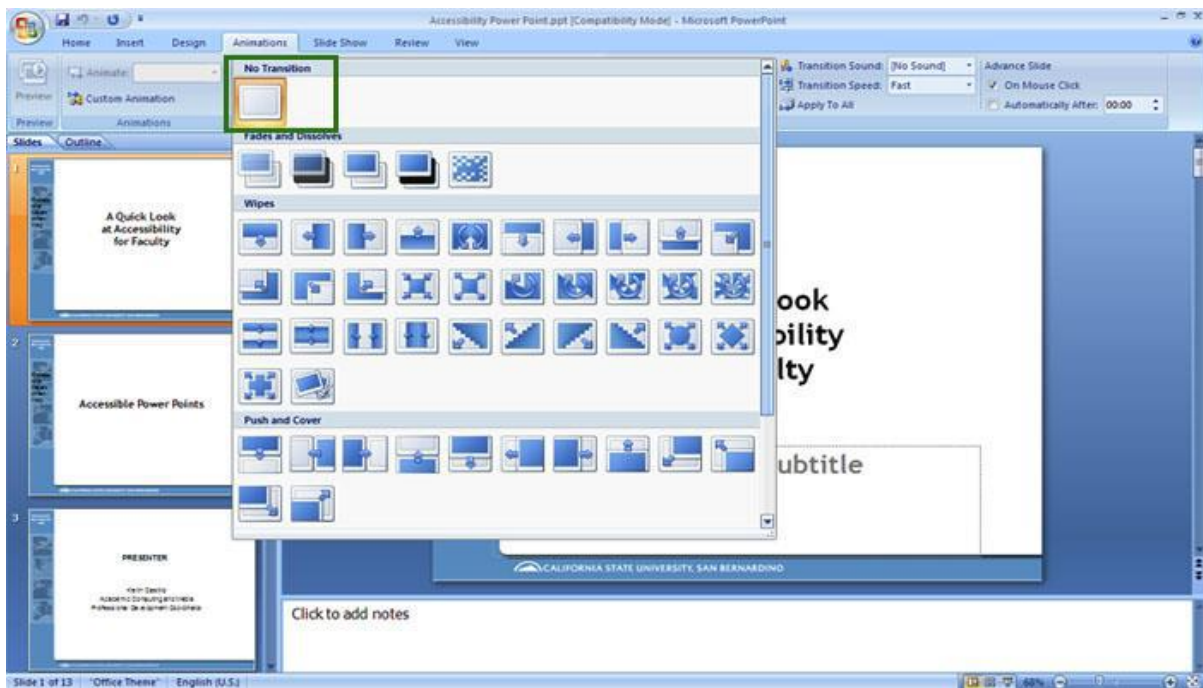

Exercise on Computer

Q.1 Create the PowerPoint presentation on introduction to computer.

Q.2 What is the difference between ppt and pptx.

Q.3 How to insert effect on ppt.

Practical No 16: Web Browsing

Web Browsing:

Web browsing means to work on the net. Today's world can't be imagined without internet. Today Internet is very powerful tool for information sharing. All the information about any organization any technology is easily available on the internet. For the web browsing we need web browser, internet



explorer, Google chrome, Mozilla Firefox, opera etc. are most common web browser today.

Web browsing simply means "explore the world". By using Google and yahoo search engine we can explore anything which is exist in the world so search engine is very powerful tools for the web browsing.

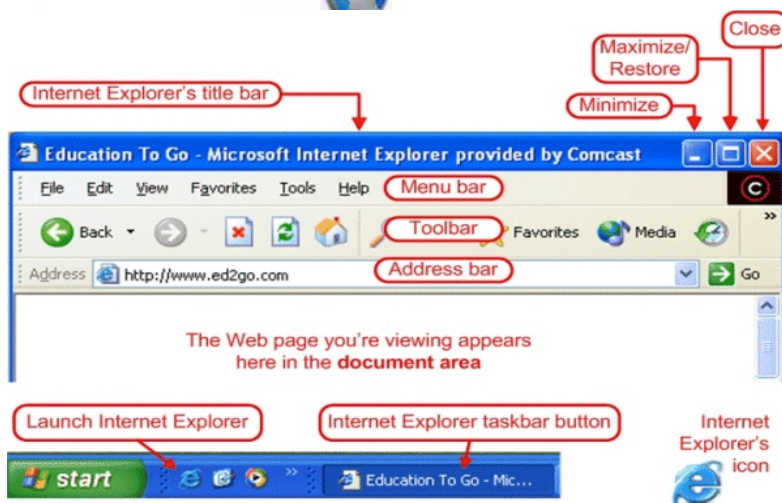

Exercise on Computer

Q.1 How to search course content on the web.

Q.2 Open the website of Rani Lakshmi Bai central Agricultural University and note content of about the university.

Practical No 17: Creation of an E-mail Account

Objective: To create e-mail Account

Email or electronic mail is most common tools for sending and receiving the data and information over the network. Today's many mail service provider companies give their services free of cost. Gmail, yahoo hot mail, rocket mail etc. are the most famous name of mail service provider. For using the mail services first user just sign up in the portal and after filling their details and once making username and password anyone can easily use the mail services.

Create your Google Account

One account is all you need
One free account gets you into everything Google.



Take it all with you
Switch between devices, and pick up wherever you left off.



Name
First Last

Choose your username
 @gmail.com

Create a password

Confirm your password

Birthday
Month Day Year

Gender
I am...

Mobile phone
 +91

Your current email address

Location
India (IN)

[Next step](#)

re=true&rm=false&continue=https://mail.google.com/mail/&ss=1&sc=1&itmpl=default<i



One account. All of Google.

Sign in to continue to Gmail



Enter your email

[Next](#)

[Find my account](#)

[Create account](#)

One Google Account for everything Google



Exercise on Computer

Q. Create own your Email Account on Gmail or any other service provider

Practical No 18: Audio Visual Aids

Audio Visual Aids

Audio visual aids are also called instructional material. Audio means hearing and video means that which found by seeing. Seeing the picture, using black and white board, seeing the movie and presentation via projector or LCD/LED monitor all are comes under audio visual aids.

The mainly use of AV aids today in education sector. There are many equipment's which are used by the teachers and students also. Interactive boards, projector, PowerPoint presentation, overhead projectors film strips flash cards are most common examples of AV aids.



Exercise

Component Parts

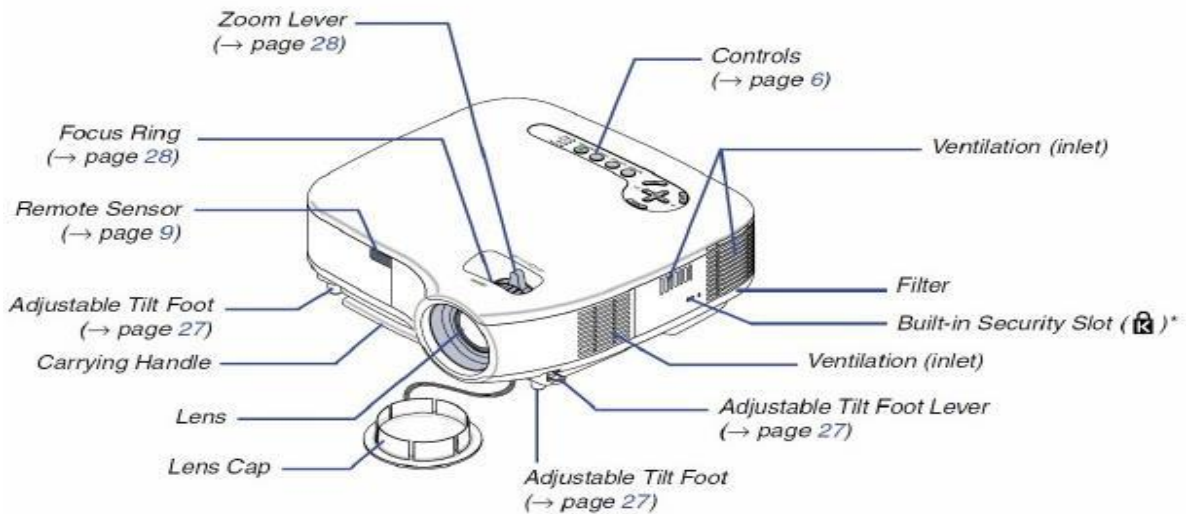

Q. Write the name of different type of AV aids.

.....

.....

.....

.....

.....

.....

.....

.....

.....